

QUIET GLIDE ROLLING LADDER INSTRUCTION MANUAL

QG.200-300-500-700 Series Hardware



GENERAL INSTALLATION/SPECIFICATION GUIDE

For QG.200, 500, 700 Series Hardware Kits

Step 1: Track Installation **Special Application Notes/Cautions:**

- 7" clearance is required above the track's centerline when the ladder is in the storage position (to avoid contacting ceiling or crown molding), and at least 3" is needed when the ladder is fully angled for climbing. (Figure 1a-b)

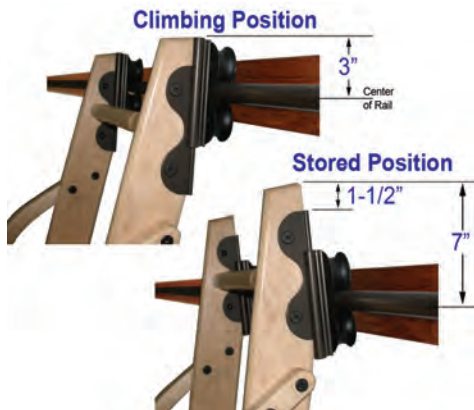

- **Do not mount track brackets directly onto a drywall surface**, even if there is solid wood behind. Track brackets will eventually crush the drywall, potentially causing the track system to fail. **Track brackets need to be installed directly onto a solid wood surface.**
- If installing a Standard Double Roller or Swivel Roller (200 or 700 Series), **ladder will need to be placed onto the track before fastening to wall and adding End Caps.**



Figure 1a

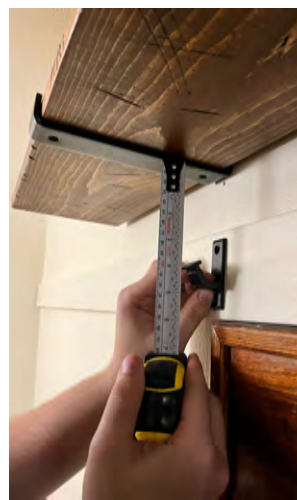

Figure 1b

If NOT using a Splice Kit to connect multiple tracks or installing End Caps, skip to page 4 for Track Installation.

Splice and End Cap Installation Special Application Notes/Cautions

- If installing a **Standard Double Roller or Swivel Roller** (200 or 700 Series), **ladder will need to be placed onto the track before adding End Caps.**

1. To connect track rails using the Quiet Glide Splice Kit (QG.41), follow these steps:

- Insert half the length of the roll pin into one of the tracks. (Figure 1a).
- Slide the steel bar halfway into the track and tighten one of the set screws. (Figure 1b).



Figure 1a



Figure 1b

- Line up the other track and slide it over the pin and bar, ensuring a snug connection. (Figures 2a & b).
- Complete the splice by tightening the remaining set screw.



Figure 2a



Figure 2b

- Slide all the brackets onto the track (brackets should be no more than 32" apart).
- Install the end caps to the rail.
- Using a 1/4"-20 tapping tool, tap the ends of the track (see Figure 3b).
- Secure the end cap to the track using the supplied 1/4"-20 KD bolt and a 4mm Allen wrench (see Figure 3c). End result is Figure 3d.

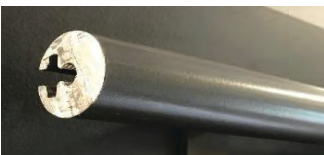

Figure 3a



Figure 3b



Figure 3c



Figure 3d



Figure 2a

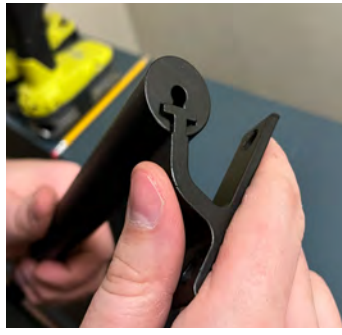

Figure 2b

2. Slide all of the brackets into the channel in the metal track (if not done from Splice Kit steps), approximating the spacing on your mounting surface. **Brackets should be no more than 32" apart.** (Figure 2a-b)



Figure 3a



Figure 3b

3. Determine the center track installation height and mark the location for the bottom of the mounting brackets. Hold the metal track up to the mounting surface—lining up your brackets with the planned locations marked. Mark the center of both the fastener holes. (Figure 3a-b)



Figure 4

4. Pre-drill your marked locations using 1/8" bit for soft wood and 13/64" for hard wood. (Figure 4)

5. Bring your metal track with brackets to your mounting surface and fasten each bracket to the wood surface with the included screws. (Figure 5)



Figure 5

Please note: If installing a Standard Double Roller or Swivel (200 or 700 Series), ladder will need to be placed onto the track before fastening to wall.



Figure 6

6. Use an accurate leveling device to ensure that the horizontal locations of the bracket and track are properly aligned. (Figure 6).

Step 2: Ladder Assembly (if applicable)

Storage:

- Store the ladder in its original packaging in a humidity-controlled environment until ready to finish/assemble.
- Lay the stored ladder on a dry, level surface, preferably off the floor (do not lean against wall for any extended period, this can cause bowing/warping of the ladder).

Surface prep:

- After removing from shipping packaging, allow the ladder parts to acclimate to the temperature/humidity of the area where the ladder will be installed. (Acclimation times vary by species and product, a guide is to acclimate the wood ladders for **at least three days**. The goal is to reach an equilibrium between the moisture content of the wood materials and the air where the product is being installed)
- Sand all wooden parts with a 220-grit sanding pad just prior to finishing. (This opens the wood pores creating a more uniform and consistent finish on the ladder)
- Remove all dust from the ladder prior to finishing.
- It is highly recommended that a high-quality top-coat finish is applied to the raw, stained, or painted wood ladder to protect and preserve the beauty of the wood.

Ladder Assembly:

Critical note: A flat, level surface is required. Use 3/4" plywood spacers under the ladder sides. (See Step 4 below):

1. Lay out the parts to be assembled on the table (Figure 1)
2. Install the nut caps for the truss rods, use a rubber mallet if necessary (Figure 2)
3. Install the truss rods loosely into the nut caps using a 5mm Allen wrench, allowing room to slide the steps into the dados (detailed in Step 5). For ladders with top turned rungs, install by gluing the top turned rung in the side rails (Figure 3-4).
4. Slide 2 plywood spacers under the ladder side rails (Figure 5-6 below). (Only use 2 spacers for this operation, additional spacers can result in uneven side rails)

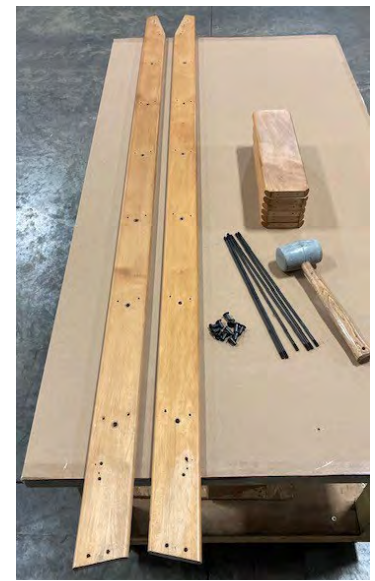

Figure 1

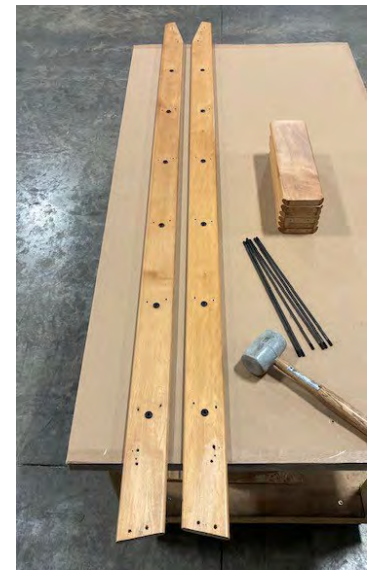

Figure 2



Figure 3



Figure 4

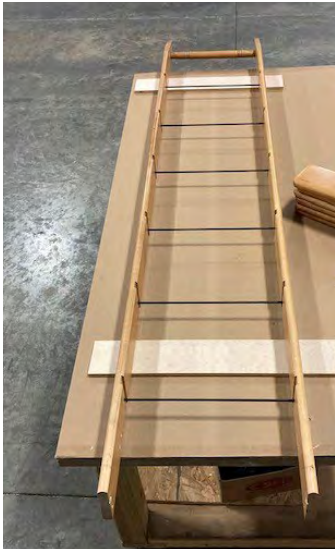

Figure 5



Figure 6

5. Slide the steps into the dados, verifying that the compound miter is lined up in the proper orientation with the dado. (Figure 7-8). Confirm that the ladder side rails are all lying flat in contact with the spacers and the bottom of the ladder side rails are even with each other and perpendicular to the sides.

6. Begin tightening the truss rods. (Do not tighten securely at this time, need to be able to adjust the height of the steps to align with the dados while fastening with the supplied screws). (Figure 9-10) Truss rods should be spaced evenly between the ladder side rails. The amount of exposed threads on the truss rods, as viewed on the inside, should be relatively even.



Figure 7



Figure 8



Figure 9



Figure 10



Figure 11



Figure 12

7. Align the compound miter of the step to the dado. Begin fastening, pushing the side rail down in tight contact with the plywood spacers (Figure 11). Completely fasten each step (both sides) before moving onto the next step. (Figure 12)

8. When all the steps have been installed, tighten the truss rods completely. (Figure 13) If assembled properly, the ladder side rails will be in tight contact with the plywood spacers (all 4 contact points). There will also be a slight, even gap between the table and the edge of the steps. (Figure 14)



Figure 13

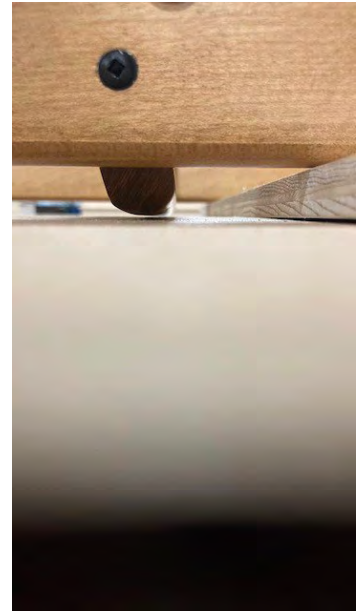

Figure 14

9. For ladders with top turned rungs, clamp the ladder side rails together and secure the top turned rung with a mechanical fastener. (Figure 15). **Acceptable fasteners:**
- 18-gauge brad nail, 1-1/2" long, or
 - 1-1/2" finish nail (4d), need to predrill using a 1/16" drill bit.



Figure 15

Step 3 Ladder Hardware Installation

Upper Hardware Assembly

1. Align the Upper Hardware Assembly on the beveled portion of the ladder by measuring down 1-1/2" from the tip of the ladder (Figure 16) (the top turned rung will be centered between the bolt holes on the side of the hardware)
2. Using a Vix bit or similar self-centering drill guide, drill a pilot hole into the edge of the ladder for the (2) #10 x 3/4" flat-head, Phillips-drive screws. Secure each Upper Hardware Assembly to the top of the ladder (Figure 17-18)



Figure 16



Figure 17



Figure 18

- Using a 1/4" drill bit, drill the holes for the 1/4-20 KD bolts on the sides of the ladder (Figure 19-21)
Recommended procedure for this:
 - Using the holes in the top roller guide as a drill guide, drill a 1/4" hole half way through the thickness of the ladder slide rail.
 - Drill the same hole on the opposite side of the top roller guide, producing a 1/4" through hole in the ladder side rail.
 - Follow this same procedure for all 4 through holes and complete the assembly by securing the top roller guide with the supplied 1/4-20 KD bolts and acorn nuts.



Figure 19



Figure 20



Figure 21

Bottom Hardware Assembly

- Place the bottom roller housing onto the bottom of the ladder using the "U" bracket portion of the housing. Verify that the bracket is flush with the bottom of the ladder.
(Because of the 12-degree angle of the bottom of the ladder this will align the housing diagonally across the ladder side rail).

- Mark the location of the "U" bracket on the bottom of the ladder, approximately 1-1/2" from the front edge of the ladder (Figure 22). At the same time mark on the side of the ladder the location of the top mounting hole of the bottom roller housing. Measure these marks and transfer these measurements to the other ladder side rail so that the hardware will mount identically on both ladder side rails.



Figure 22

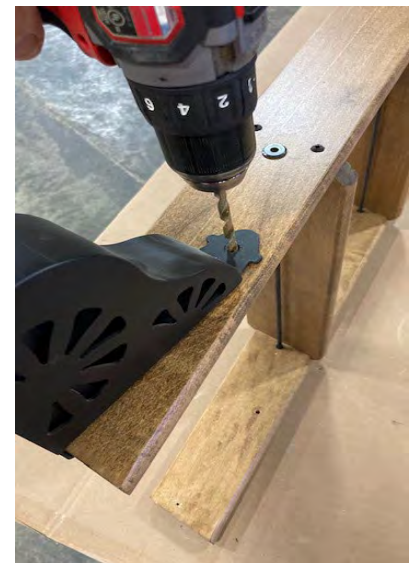

Figure 23

- Using a 1/4" drill bit, drill a through hole in the ladder side rail for the 1/4-20 KD bolt (Figure 23)

- Pre-drill the ladder side rail for the #10 x 3/4" screw using a 1/8" drill bit. (This is critical step to help avoid splitting the wood, which can lead to failure of the ladder when weight is applied)

- Install both the bottom roller guides using the included screws and KB bolts and acorn nuts.

Bottom Wheel Locking Adjustment (Breaking Wheels only) (Figure 24-25)

The amount of weight needed to engage the breaking mechanism on the breaking bottom wheel assemblies is adjustable, the unit is preset for approximately 70 lbs.

1. Steps for adjustment (Use a 7/32" Allen wrench for adjustments)
2. Locate the Allen drive screw in the bottom of the wheel housing (see blue box below)
3. To decrease sensitivity (need more weight to engage breaking mechanism), turn screw clockwise.
4. To increase sensitivity (need less weight to engage breaking mechanism), turn screw counterclockwise.
(Be careful not to loosen too much to prevent the spring from falling out)



Figure 24



Figure 25



Hook your ladder onto the track.

**Congratulations on
completing your Quite Glide
Ladder!**



Please consider leaving a review on
Google Reviews or cshardware.com!

Any questions? Please call CSH
Customer Service at **262-375-7960**
M-F 8:00am-4:30pm CST
or email service@cshardware.com

Dimensional Specifications

Top Ladder Hardware

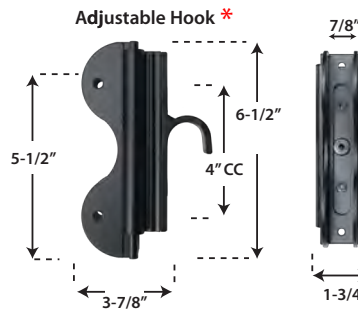
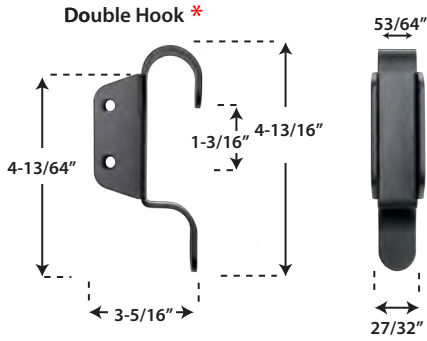
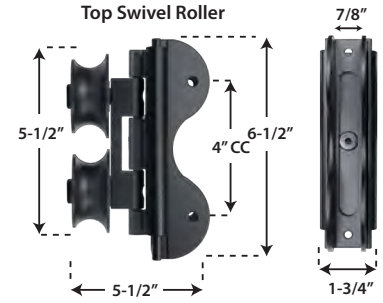
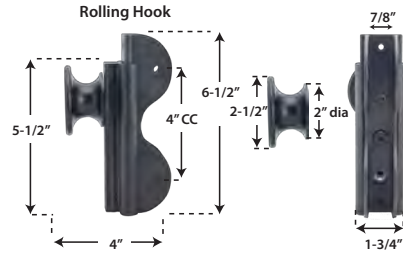
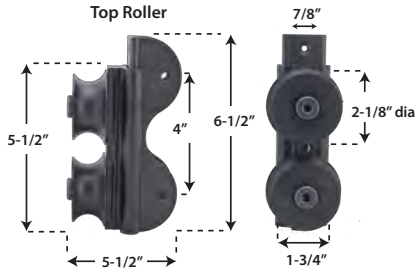

* Designed For Loft Applications

Bottom Ladder Hardware

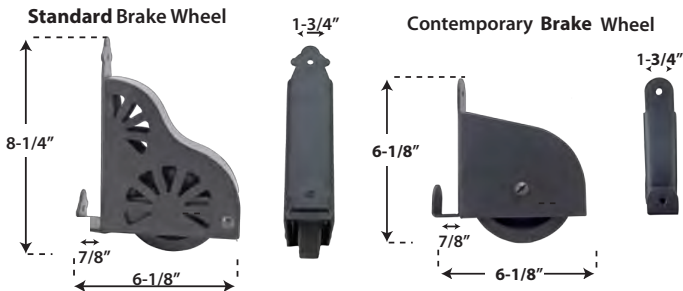
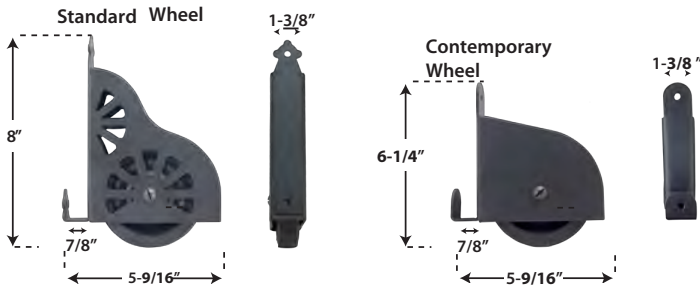

Vertical Rail Brackets

For Roller and Swivel Top Guides

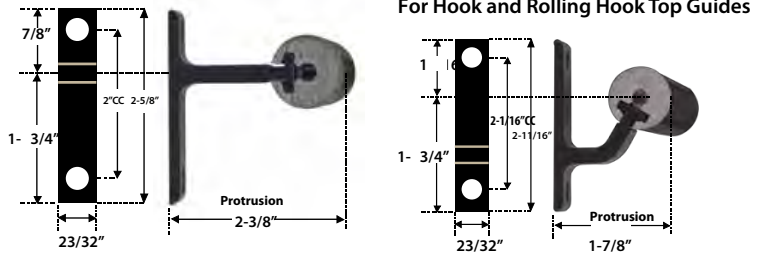

Horizontal Rail Brackets

For Roller and Swivel Top Guides

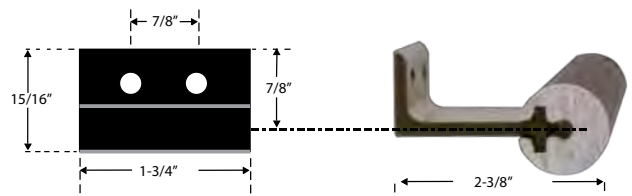

For Hook and Rolling Hook Top Guides

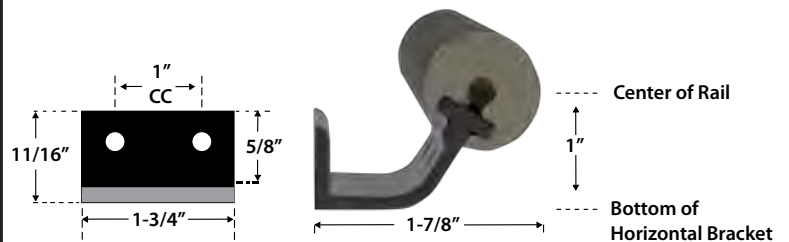

Rail Height and Distance

for 8', 9', 10' standard ladders

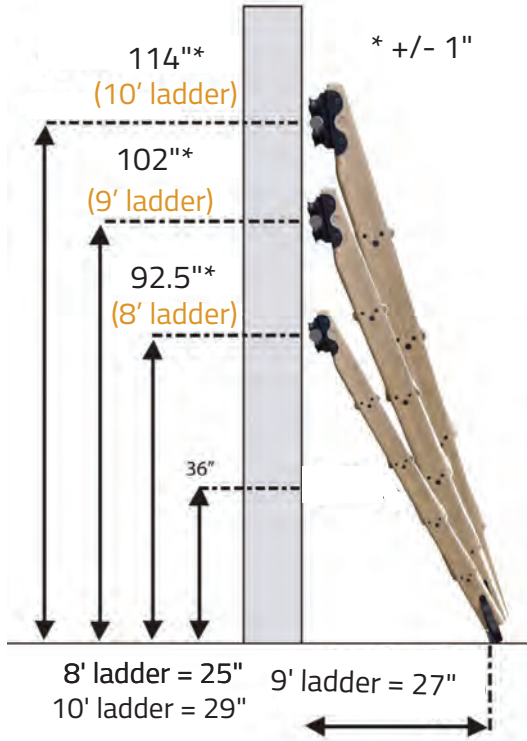

Approximate Distance from wall (ladder in climbing position)

Hand Rail dimensions

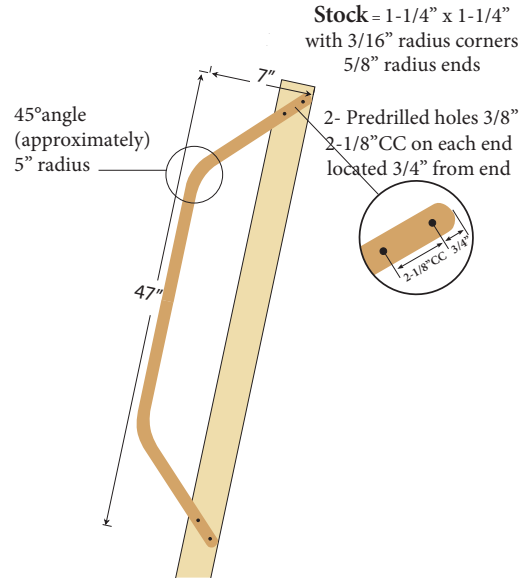

Curved rail radius dimensions

Hook top Hardware cannot be used with curved rails!

Rail Diameter = 1"

135°

